

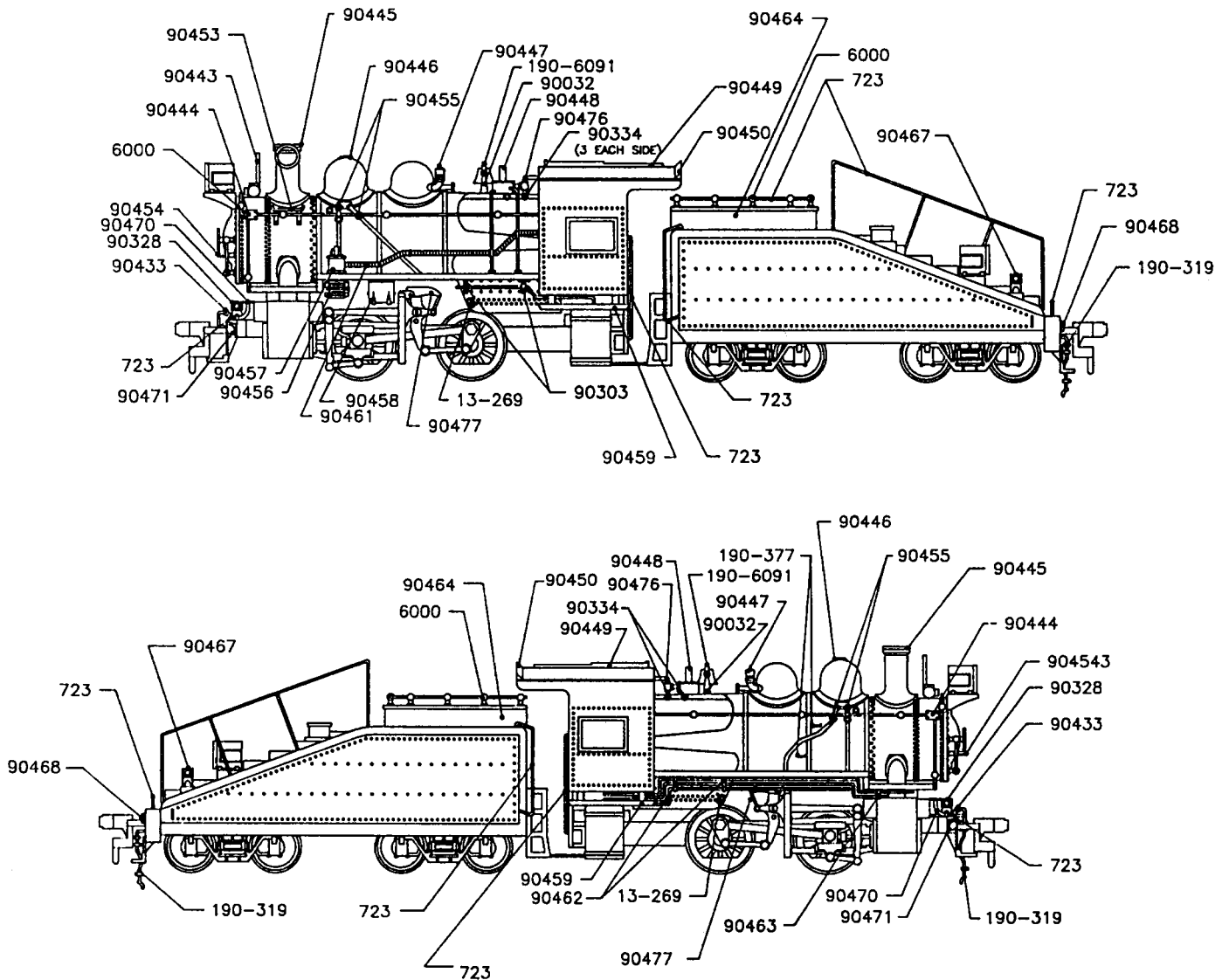





















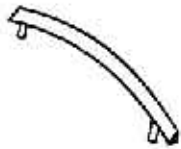





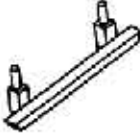
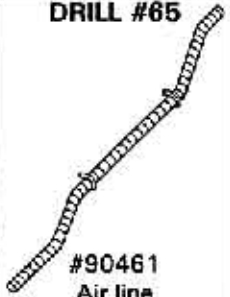

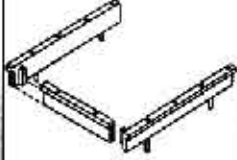

PRR A-5 SHIFTER 0-4-0

SUPER DETAIL KIT #100580



<u>PART#</u>	<u>DESCRIPTION</u>	<u>PIECES</u>	<u>PART#</u>	<u>DESCRIPTION</u>	<u>PIECES</u>
723	.020 x 6" wire	6	90456	Air compressor bottom	1
744	.032 x 6" wire	1	90457	Air compressor top	1
6000	Handrail stanchions	16	90458	Train control box	1
90032	Bell bracket	1	90459	Cab step	2
90303	Large pipe bracket	2	90461	Air line	1
90328	Straight marker light	4	90462	Pipe hanger, 3 hole	2
90433	Coupler lift bar stanchions	2	90463	Pipe hanger, 2 hole	1
90334	Stay bolts	6	90464	Coal load extension, 3 pcs.	1
90443	Generator	1	90467	Marker light	2
90444	Junction box	2	90468	Poling pockets	2
90445	Smoke stack lid	1	90470	Pilot steps	2
90446	Dome hatch	1	90471	Pilot poling pockets, curved base	2
90447	Pop valve & whistle	1	90477	Valve gear reverse lifter	2
90448	Exhaust muffler w/ pipes	1	90478	Turret valve	1
90449	Cab hatch	1	13-269	Inspection plug	2
90450	Wind deflector	1	190-319	Air hose	2
90453	Smoke stack deck	1	190-377	Boiler steps	2
90454	Smoke stack front step	2	190-6091	Bell	1
90455	Sand line	4	100582	Engineer & fireman, set	1

PRR A-5 SUPERDETAIL KIT #100580 - PARTS IDENTIFICATION SHEET

<p>DRILL #52</p>  <p>#90328 Straight marker light</p>	<p>DRILL #65</p>  <p>#90303 Large pipe bracket</p>	<p>DRILL #60 2X SIZE</p>  <p>#90334 Stay bolts (4 pcs.)</p>	<p>DRILL #60 2X SIZE</p>  <p>#90433 Coupler lift bar stanchions</p>	<p>DRILL #60</p>  <p>#90443 Generator</p>	<p>CLEAN HOLES w/ DRILL #77 2X SIZE</p>  <p>#90444 Junction box (2 pcs.)</p>
 <p>#90445 Smoke stack lid</p>	<p>DRILL #52 2X SIZE</p>  <p>#90446 Dome hatch</p>	<p>DRILL #47</p>  <p>#90447 Pop valve & Whistle</p>	<p>DRILL #52</p>  <p>#90448 Exhaust muffler w/ pipes</p>	<p>DRILL #52 1/2 SIZE</p>  <p>#90449 Cab hatch</p>	<p>DRILL #65</p>  <p>#90450 Wind deflector</p>
<p>DRILL #65</p>  <p>#90453 Smoke stack deck</p>	<p>DRILL #65 2X SIZE</p>  <p>#90454 Smoke stack front step (2 pcs)</p>	<p>DRILL #65</p>  <p>#90455 Sand line (2 pcs.)</p>	<p>DRILL #52</p>  <p>#90456 Air compressor Bottom</p>	<p>DRILL #52</p>  <p>#90457 Top air compressor</p>	<p>DRILL #52</p>  <p>#90458 Train control box</p>
<p>DRILL #62</p>  <p>#90459 Cab step (2 pcs.)</p>	<p>DRILL #65</p>  <p>#90461 Air line</p>	<p>DRILL #71 SEE DRILL TEMPLATE #1 2X SIZE</p>  <p>#90462 Pipe hanger, 3 hole (2 pcs.)</p>	<p>DRILL #71 SEE DRILL TEMPLATE #1 2X SIZE</p>  <p>#90463 Pipe hanger, 2 hole</p>	<p>DRILL #65 1/2 SIZE</p>  <p>#90464 Coal load extension</p>	<p>DRILL #55</p>  <p>#90467 Marker light (2 pcs.)</p>
<p>DRILL #53 2X SIZE</p>  <p>#90468 Poling pockets (2 pcs.)</p>	<p>DRILL #71</p>  <p>#90470 Pilot steps (2 pcs.)</p>	<p>DRILL #53 2X SIZE</p>  <p>#90471 Pilot poling pocket CURVED BASE (2 pcs.)</p>	<p>DRILL #66</p>  <p>#90478 Turret valve</p>	<p>DRILL #65 2X SIZE</p>  <p>#13-269 Inspection plug (2 pcs.)</p>	<p>DRILL #65</p>  <p>#190-319 Air hose</p>
<p>DRILL #65 2X SIZE</p>  <p>#190-377 Boiler steps (2 pcs.)</p>	<p>DRILL #65 2X SIZE</p>  <p>#6000 Handrail stanchions</p>	 <p>#190-6091 Bell</p>	<p>DRILL #52</p>  <p>#90032 Bell Bracket</p>	<p>SEE DRAWING #8</p>  <p>#90477 Valve gear reverse lifter</p>	

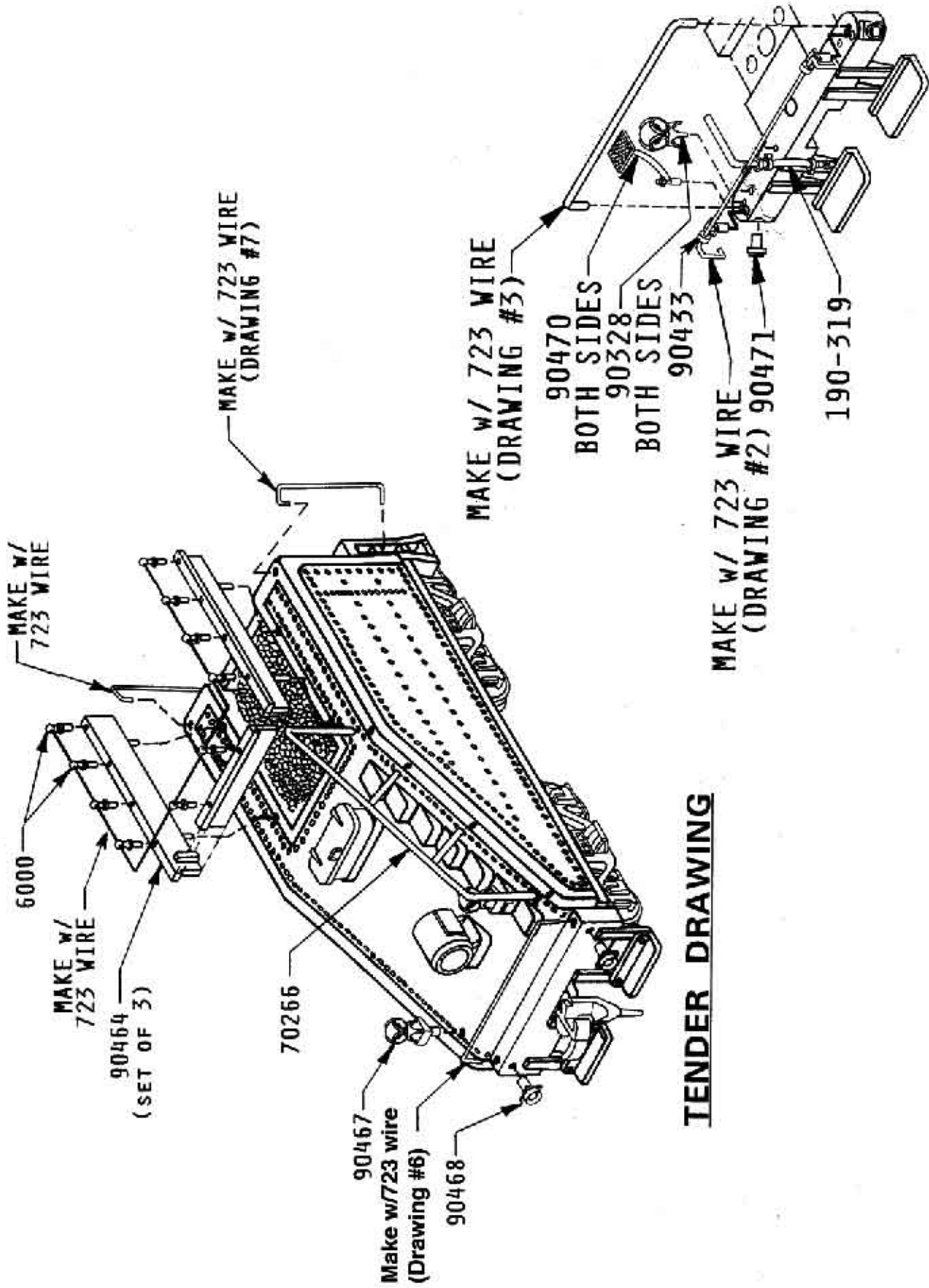

#100580
A-5

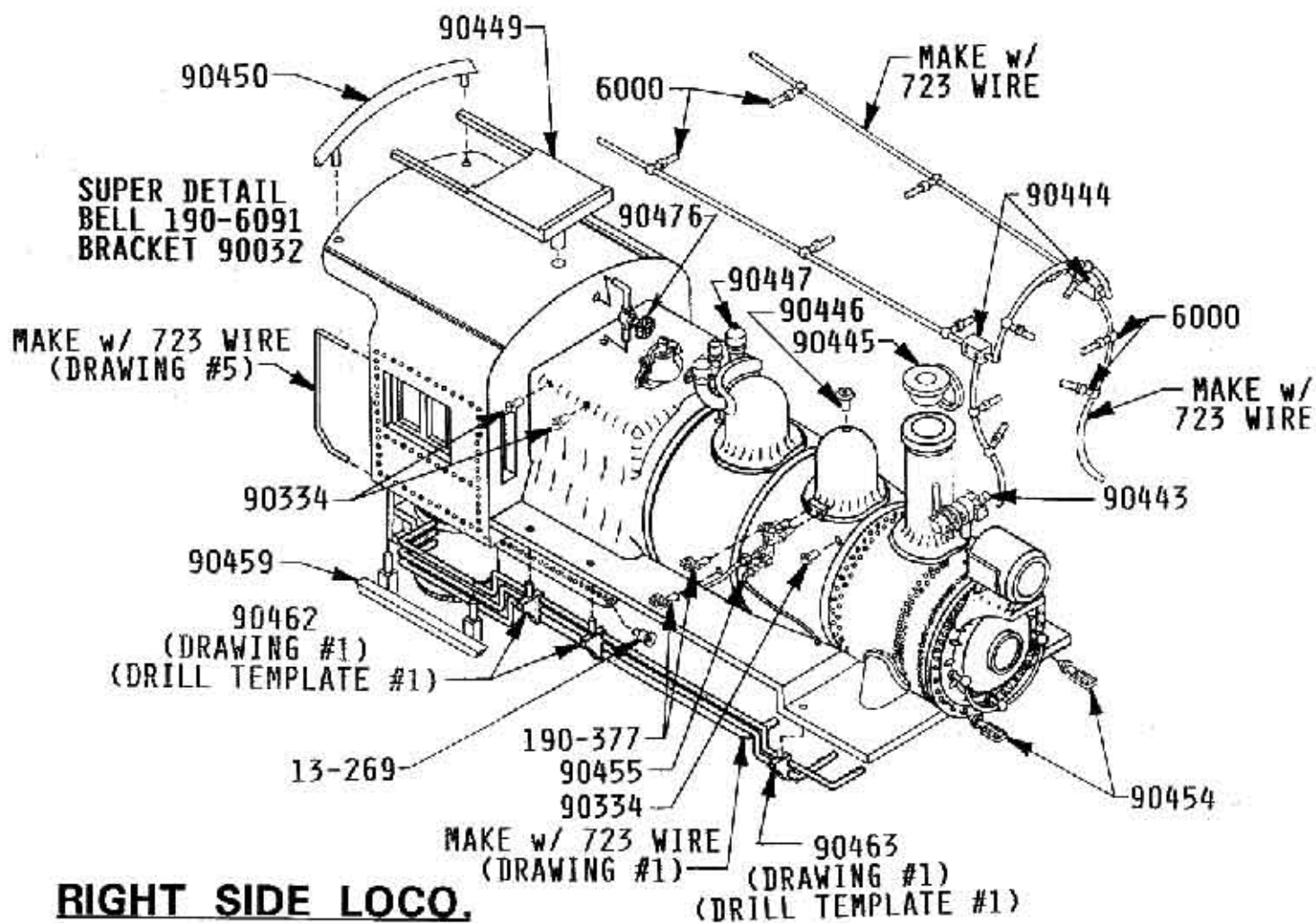
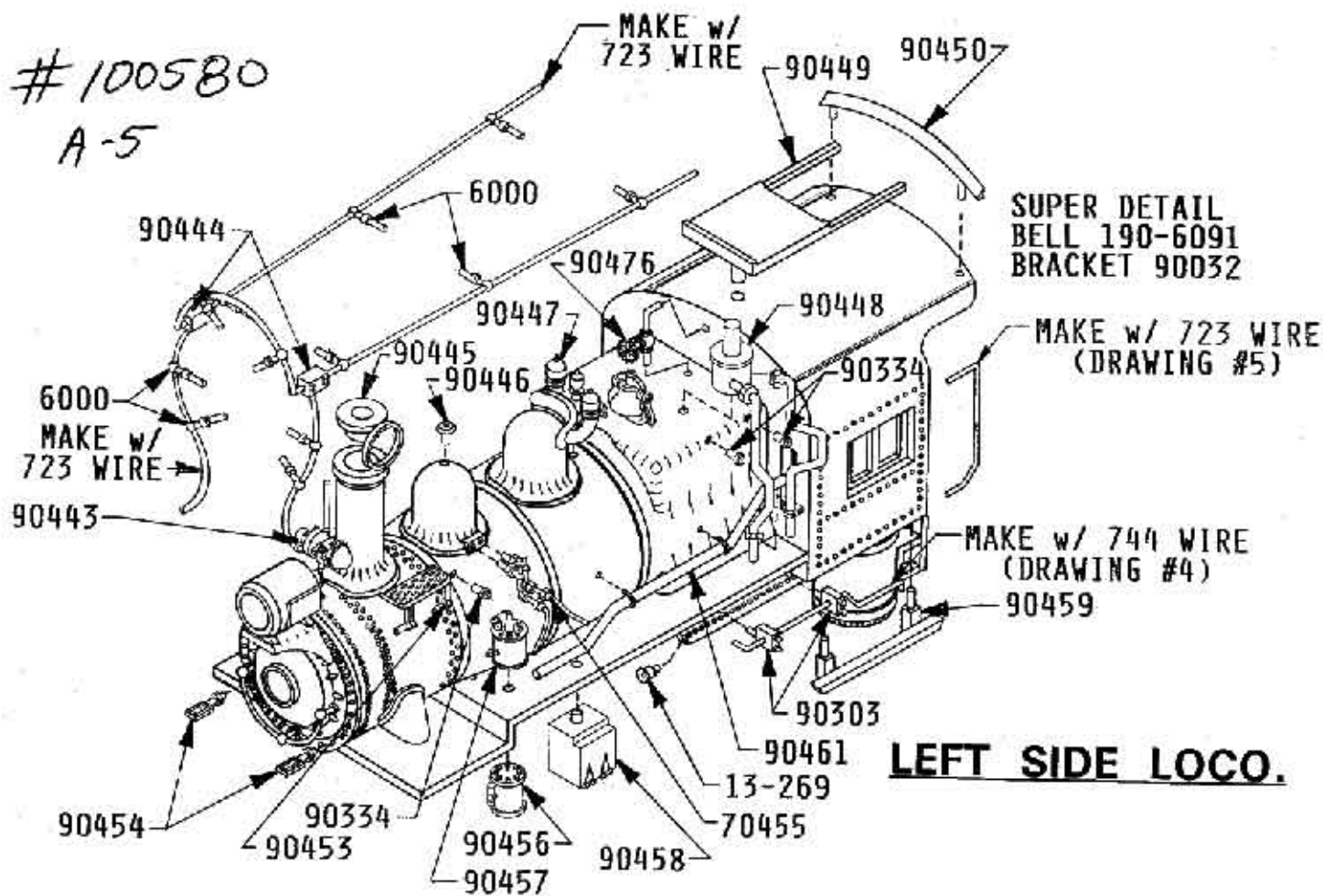

BOWSER PRR A-5 SUPERDETAIL KIT #100580

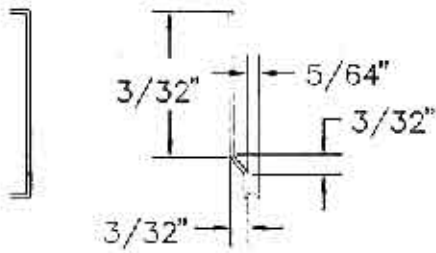

LEFT SIDE



RIGHT SIDE

DRAWING #5

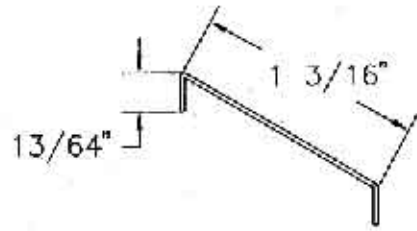

TENDER REAR HANDRAIL

DRAWING #6

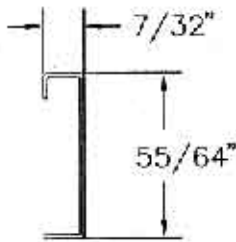

2 - REQUIRED

DRAWING #7

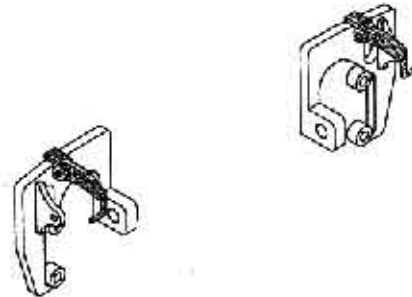

1) GLUE VALVE GEAR REVERSE LIFT #90477
 ONTO VALVE GEAR HANGERS #90472 & #90473

DRAWING #8

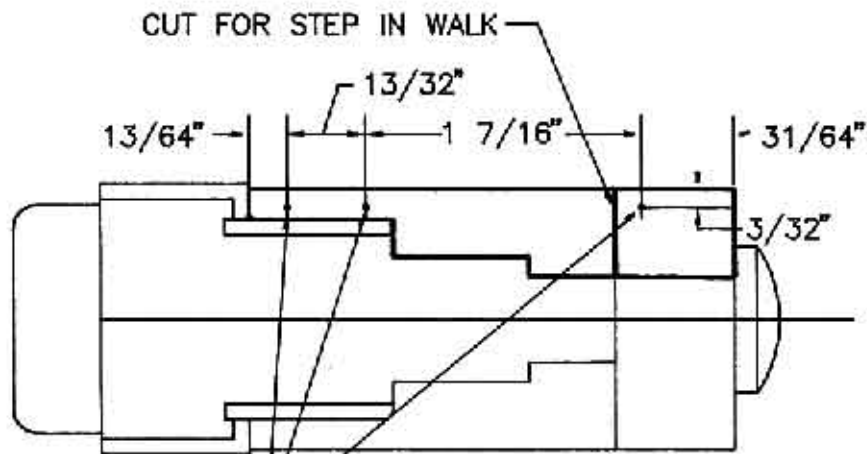

DRILL #71 - 3 HOLES
 RIGHT SIDE LOCO ONLY

- 1) CUT ON HEAVY LINE
- 2) PLACE ON UNDERSIDE RIGHT LOCO BODY
- 3) DRILL (3) #71 HOLES

VIEW OF UNDERSIDE LOCO. BODY

DRILL TEMPLATE #1

INSTRUCTIONS FOR BOWSER A-5 SHIFTER SUPERDETAIL KIT #100580

- 1) Study the photos and all drawings carefully.
- 2) Identify all parts w/ Identification sheet.
- 3) Form all handrail wire. See drawings.
- 4) Locate the proper positions for the superdetail parts.
- 5) Drill all holes. See drill template #1 for right side piping hangers. See parts Identification sheet for drill sizes. Donot glue any details or handrail until you have drilled and checked all pieces.

NOTE: ALL WIRE FORM DRAWINGS AND DRILL TEMPLATES ARE FULL SIZE

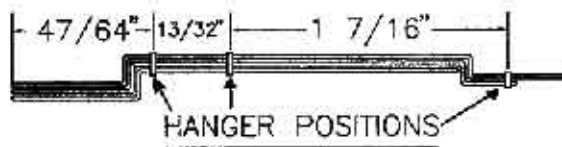
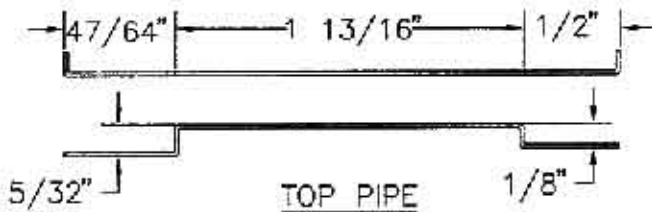
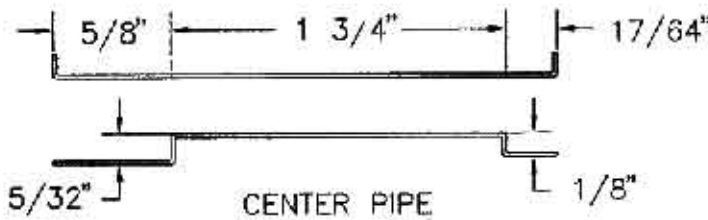
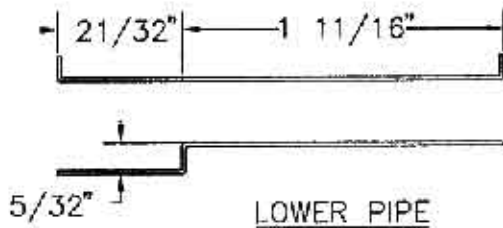

- 1) PLACE HANGERS ONTO 723 WIRE.
- 2) BEND WIRE AS SHOWN.
- 3) SEE DRILL TEMPLATE #1.
- 4) GLUE HANGERS ONTO WALK
- 5) GLUE HANGERS TO WIRE

DRAWING #1

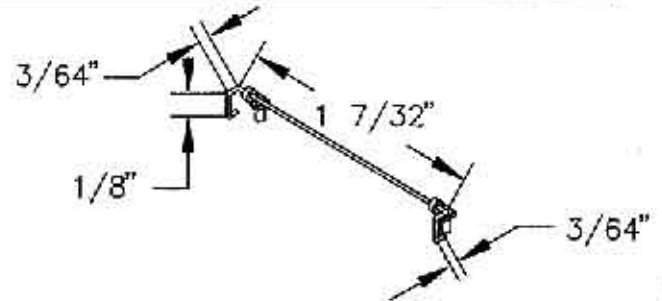

- 1) PLACE HANGERS ON WIRES
- 2) BEND WIRE AS SHOWN
- 3) NO NOT GLUE WIRE TO HANGERS

DRAWING #2

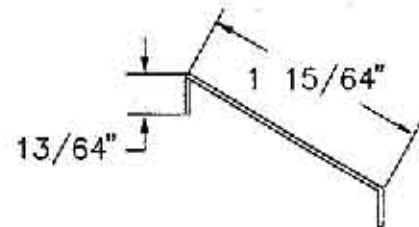

LOCO FRONT HANDRAIL

DRAWING #3

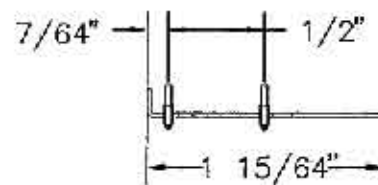

- 1) PLACE HANGERS ON WIRE
- 2) BEND WIRE AS SHOWN
- 3) GLUE WIRES TO HANGERS

DRAWING #4

